

Natural Sound Digital Surround Decoder

DSR-70PRO

OPERATION MANUAL

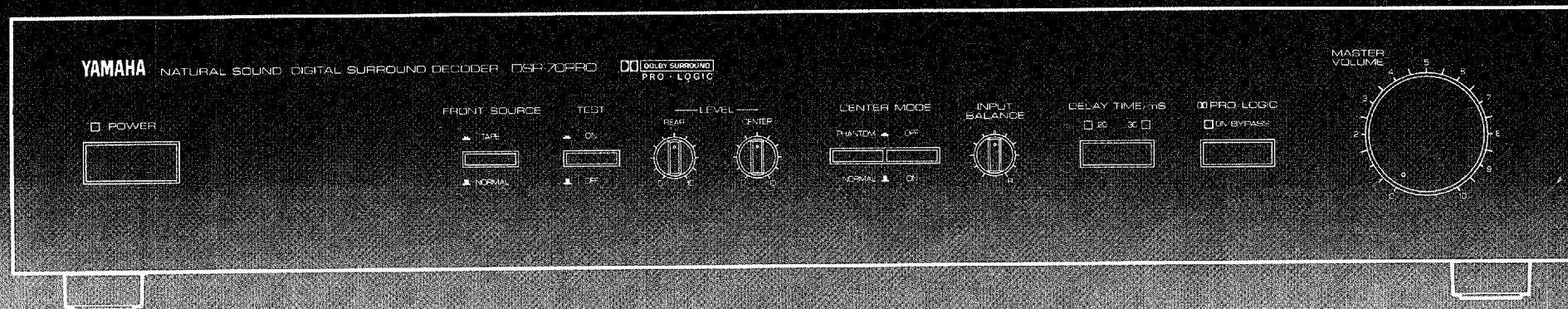

CENTER

YAMAHA

SAFETY INSTRUCTIONS

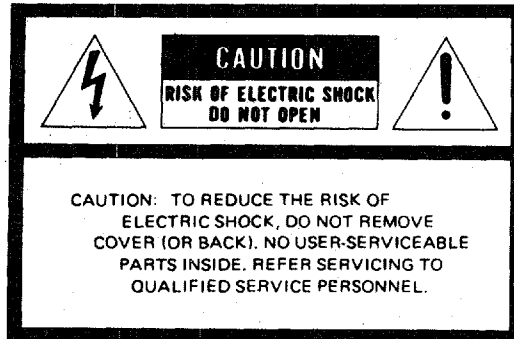

Explanation of Graphical Symbols



The lightning flash with arrowhead symbol within an equilateral triangle, is intended to alert you to the presence of uninsulated "dangerous voltage" within the product's enclosure that may be sufficient magnitude to constitute a risk of electric shock to persons.



The exclamation point within an equilateral triangle is intended to alert you to the presence of important operating and maintenance (servicing) instructions in the literature accompanying the appliance.

WARNING

To reduce the risk of fire or electric shock, do not expose this appliance to rain or moisture.

1 Read instructions—All the safety and operating instructions should be read before the appliance is operated.

2 Retain instructions—The safety and operating instructions should be retained for future reference.

3 Heed Warnings—All warnings on the appliance and in the operating instructions should be adhered to.

4 Follow Instructions—All operating and other instructions should be followed.

5 Water and Moisture—The appliance should not be used near water—for example, near a bathtub, washbowl, kitchen sink, laundry tub, in a wet basement, or near a swimming pool, etc.

6 Cart and Stands—The appliance should be used only with a cart or stand that is recommended by the manufacturer.

6A An appliance and cart combination should be moved with care. Quick stops, excessive force, and uneven surfaces may cause the appliance and cart combination to overturn.



7 Wall or Ceiling Mounting—The appliance should be mounted to a wall or ceiling only as recommended by the manufacturer.

8 Ventilation—The appliance should be situated so that its location or position does not interfere with its proper ventilation. For example, the appliance should not be situated on a bed, sofa, rug, or similar surface that may block the ventilation openings, or cabinet that may impede the flow of air through the ventilation openings.

9 Heat—The appliance should be situated away from heat sources such as radiators, stoves, or other appliances that produce heat.

10 Power Sources—The appliance should be connected to a power supply only of the type described in the operating instructions or as marked on the appliance.

11 Power-Cord Protection—Power-supply cords should be routed so that they are not likely to be walked on or pinched by items placed upon or against them, paying particular attention to cords at plugs, convenience receptacles, and the point where they exit from the appliance.

12 Cleaning—The appliance should be cleaned only as recommended by the manufacturer.

13 Nonuse Periods—The power cord of the appliance should be unplugged from the outlet when left unused for a long period of time.

14 Object and Liquid Entry—Care should be taken so that objects do not fall into and liquids are not spilled into the inside of the appliance.

15 Damage Requiring Service—The appliance should be serviced by qualified service personnel when:

- A. The power-supply cord or the plug has been damaged; or
- B. Objects have fallen, or liquid has been spilled into the appliance; or
- C. The appliance has been exposed to rain; or
- D. The appliance does not appear to operate normally or exhibits a marked change in performance; or
- E. The appliance has been dropped, or the cabinet damaged.

16 Servicing—The user should not attempt to service the appliance beyond those means described in the operating instructions. All other servicing should be referred to qualified service personnel.

17 Power lines—An outdoor antenna should be located away from power lines.

18 Grounding or Polarization—Precautions should be taken so that the grounding or polarization of an appliance is not defeated.

19 This equipment generates and uses radio frequency energy and if not installed

and used properly, that is, in strict accordance with the manufacturer's instructions, may cause interference to radio and television reception. It has been type tested and found to comply with the limits for a Class B computing device in accordance with the specifications in Subpart J of Part 15 of FCC Rules, which are designed to provide reasonable protection against such interference in a residential installation. However, there is no guarantee that interference will not occur in a particular installation. If this equipment does cause interference to radio or television reception, which can be determined by turning the equipment off and on, the user is encouraged to try to correct the interference by one or more of the following measures:

- Reorient the receiving antenna
- Relocate the DSR-70PRO with respect to the receiver
- Move the DSR-70PRO away from the receiver
- Plug the DSR-70PRO into a different outlet so that the DSR-70PRO and receiver are on different branch circuits.

If necessary, the user should consult the dealer or an experienced radio/television technician for additional suggestions. The user may find the following booklet prepared by the Federal Communications Commission helpful: "How to Identify and Resolve Radio-TV Interference Problems". This booklet is available from the U.S. Government Printing Office, Washington, DC 20402, Stock No. 004-000-00345-4.

IMPORTANT!

Please record the serial number of your unit in the space below.

Model: **DSR-70PRO**
Serial No.:

The serial number is located on the rear of the unit.
Retain this Owner's Manual in a safe place for future reference.

Congratulations

You are now the proud owner of a Yamaha DSR-70PRO Dolby Pro Logic Surround Decoder. This sophisticated digital surround decoder lets you experience the dramatic realism and impact of Dolby Surround movie theater sound in your own home.

Dolby Pro Logic Surround gets its name from its professional-grade directional logic circuitry, which provides greater effective channel separation for a much higher degree of realism than the "passive" Dolby Surround circuits found in today's typical home audio/video equipment. With a suitable complement of surround amplifiers and speakers, the DSR-70PRO can bring you an exciting, dramatic listening experience that goes beyond.

To assure maximum performance and trouble-free operation, refer to the connection recommendations and operating instructions in this manual. Be sure to store the manual in a safe place for future reference.

CONTENTS

PRECAUTIONS & SAFETY INSTRUCTIONS	2
SECTION 1 — SETUP & ADJUSTMENT	3
1-1. GETTING STARTED	3
1-2. SYSTEM CONFIGURATIONS	3
1-3. SETUP	6
1-4. CONTROLS & ADJUSTMENTS	15
SECTION 2 — PREPARATION	17
2-1. PREPARATION	17
2-2. INPUT BALANCE ADJUSTMENT	17
2-3. FRONT/CENTER/REAR SPEAKER BALANCE ADJUSTMENT	18
SECTION 3 — GENERAL OPERATION	19
3-1. PLAYBACK WITH DOLBY SURROUND	19
3-2. ORDINARY STEREO REPRODUCTION	19
3-3. SOURCE SELECTION WITH TAPE LOOP CONNECTION	19
3-4. RECORDING ON A DECK CONNECTED TO THE DSR-70PRO	19
SECTION 4 — APPENDIX	20
4-1. TROUBLESHOOTING	20
4-2. SPECIFICATIONS	21

PRECAUTIONS & SAFETY INSTRUCTIONS

1. AVOID EXCESSIVE HEAT, HUMIDITY, DUST AND VIBRATION

Keep the unit away from locations where it is likely to be exposed to high temperatures or humidity—such as near radiators, stoves, etc. Also avoid locations which are subject to excessive dust accumulation or vibration which could cause mechanical damage.

2. AVOID PHYSICAL SHOCKS

Strong physical shocks to the unit can cause damage. Handle it with care.

3. DO NOT OPEN THE UNIT OR ATTEMPT REPAIRS OR MODIFICATIONS YOURSELF

This product contains no user-serviceable parts. Refer all maintenance to qualified Yamaha service personnel. Opening the unit and/or tampering with the internal circuitry will make servicing difficult and will endanger you and your DSR-70PRO.

4. MAKE SURE POWER IS OFF BEFORE MAKING OR REMOVING CONNECTIONS

Always turn the power OFF prior to connecting or disconnecting cables. This is important to prevent damage to the unit itself as well as other connected equipment.

5. HANDLE CABLES CAREFULLY

Always plug and unplug cables—including the AC cord—by gripping the connector, not the cord.

6. CLEAN WITH A SOFT DRY CLOTH

Never use solvents such as benzine or thinner to clean the unit. Wipe clean with a soft, dry cloth.

7. ALWAYS USE THE CORRECT POWER SOURCE

Make sure that the power source voltage specified on the rear panel matches your local AC mains supply.

SECTION 1 — SETUP & ADJUSTMENT

1-1. GETTING STARTED

Unpacking

Carefully remove the DSR-70PRO from its packing box. With the DSR-70PRO you will find connection cables for connection to your system.

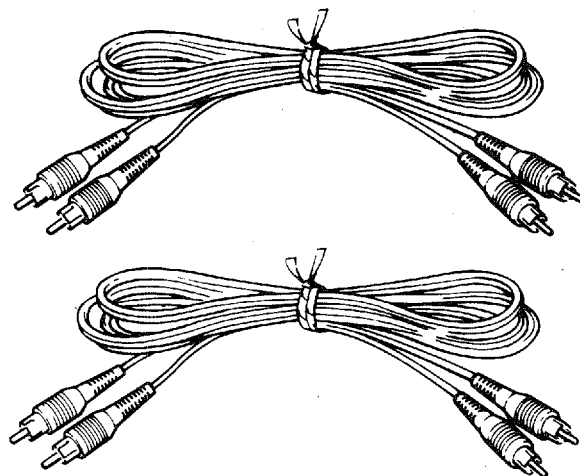

Pin cables (2)

1-2. SYSTEM CONFIGURATIONS

Amplification and Speaker Arrangements

The Basic System

To approach as nearly as possible the dynamic sound of professional Dolby systems in movie theaters do, the DSR-70PRO "active" circuit configuration breaks the Dolby Surround encoded stereo signal into several different channels: a center channel for dialog, the main left and right channels, and rear surround channels. A typical system setup includes five speakers with appropriate amplifiers. The center dialog speaker is placed adjacent to the screen, the main speakers are placed in their usual positions for stereo listening, and surround speakers are placed at the left and right sides in the rear.

If for some reason it is not practical to use five speakers, it is possible to eliminate the center dialog speaker. The "phantom" mode is used in this case to route the dialog to the main speakers. Best results are obtained with the full five-speaker system, however.

It is also possible to further expand your system with the addition of a subwoofer and amplifier. The subwoofer should be placed in the rear of the room in the center.

NOTE: The Yamaha MX-35 power amplifier (which provides four channels of amplification) is recommended to satisfy your additional amplification system needs.

SETUP & ADJUSTMENT

Dolby Pro Logic Surround Technical Notes

The DSR-70PRO uses an "active" circuit configuration which is similar to professional Dolby stereo decoders employed in movie theaters. How is this different from the "passive" decoders found in typical home equipment?

The Dolby Pro Logic Surround system is distinguished by logic circuitry that emphasizes "directional" information by proportionally canceling unwanted crosstalk. Taking the left and right channel signals as its input, the DSR-70PRO first produces two additional signals, a left-plus-right signal (L+R) for the center channel and a left-minus-right signal (L-R) for the rear surround channel. It then compares the levels of these four signals, L, R, L+R, and L-R. Based on these level differences, the DSR-70PRO emphasizes particular channels. For example, dialog is characterized by an increase in L+R signal level. When this is detected, the DSR-70PRO routes dialog to the center channel. As this results in a slight drop in the

signal level sent to the left and right speakers, the DSR-70PRO boosts the center channel slightly to maintain overall volume at a constant level. Similarly, when L-R signal level is high, the DSR-70PRO boosts the surround channel level and reduces left and right channel levels. This results in the high dynamic range and sharp effective channel separation of 26—40dB. Dolby Pro Logic Surround provides a true center channel, so that there are four independent channels, unlike passive Dolby Surround which in effect has only three channels, left, right and rear.

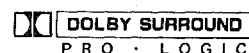

Manufactured under license from Dolby Laboratories Licensing Corporation. Additionally licensed under one or more of the following patents: U.S. numbers 3632886, 3746792 and 3959590; Canadian numbers 1004603 and 1037887. "Dolby" and the Double-D symbol are trademarks of Dolby Laboratories Licensing Corporation.

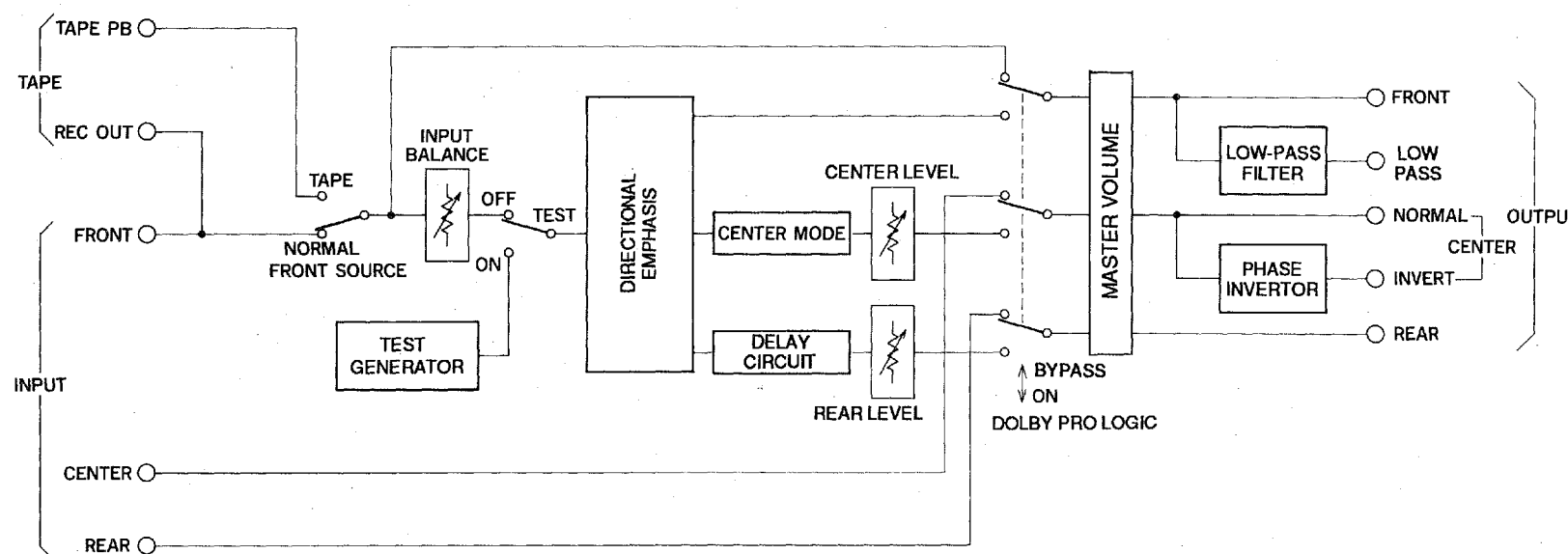

SETUP & ADJUSTMENT

Equipped with Center Switch to Match Your System

On the front panel of the DSR-70PRO you will find a CENTER MODE PHANTOM/NORMAL switch. This has an important role in matching DSR-70PRO operation to the capabilities of your audio system.

- When this switch is at the NORMAL position, a center channel signal is provided to the center output jack. Information below 100Hz is fed to the left and right main speakers, so you can use a relatively small speaker system for center channel reproduction.
- If not using a center speaker, you should set this switch to the PHANTOM position. This allocates all center channel information to the left and right main speakers.

Receivers and Integrated Amps vs. Separate Pre- and Power Amps

If your current hi-fi system is built around a receiver or integrated amp then you can continue to use it for source selection and to drive your main (front) speakers.

However, you may notice that sound quality is better with a separate preamp and power amp.

For the center channel, you may wish to purchase a mono power amp. For the rear surround speakers, additional stereo power amps are the optimum solution. However, if you already own an extra receiver or integrated amp, then it can be used just as well.

For subwoofer output you may wish to choose the convenience and sound quality of a Yamaha Active Servo Processing Super Woofer System which has its own built-in power amp.

Otherwise, you will need another mono amp and a single subwoofer speaker system.

SETUP & ADJUSTMENT

1-3. SETUP

Before You Start Making Connections Make Sure that the DSR-70PRO and All Related Electronic Components are Turned Off.

REAR PANEL

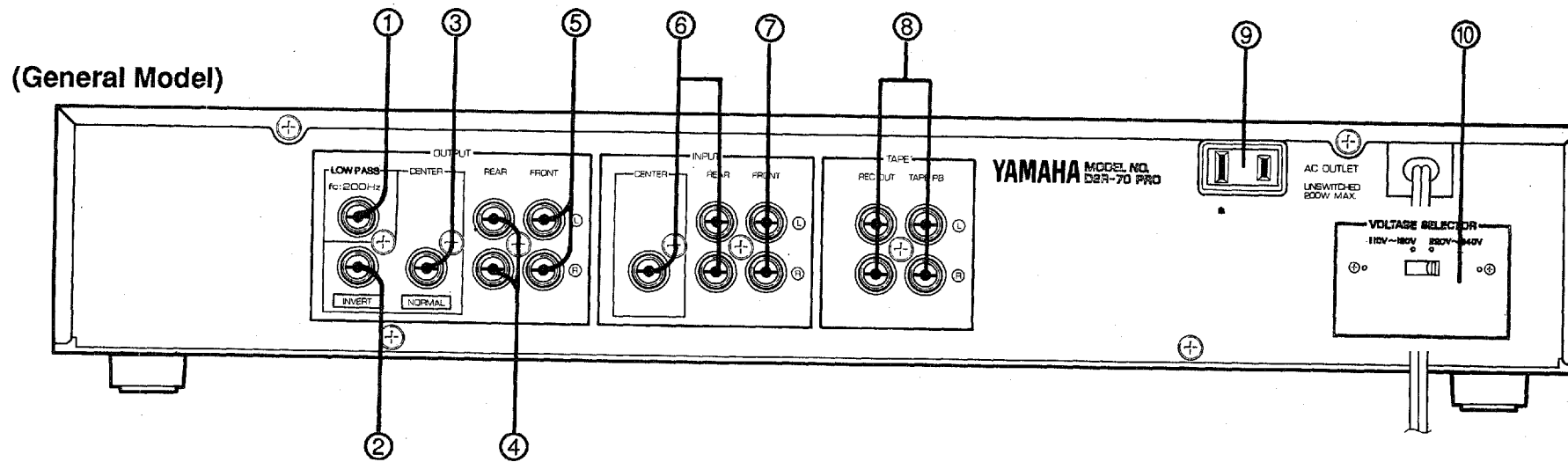

① Center Subwoofer Output Jack

Use this jack for output to a mono amplifier driving a subwoofer. This output operates regardless of the positions of the center mode switch. Frequencies above 200Hz are filtered out so only the bass range remains.

② Center Output Jack (Invert Phase)

This provides the same center channel output as the Normal phase jack, but the signal phase is inverted. Can be used with a BTL stereo amp to be used to drive the center speaker.

③ Center Output Jack (Normal Phase)

This jack provides the Dolby Surround center channel signal. Use this for output to an amplifier driving a center speaker.

A signal is output to this jack when the front panel Dolby Pro Logic switch is on. Also the Center Mode PHANTOM/NORMAL switch must be set to NORMAL and the Center Mode On/Off switch set to ON for this to

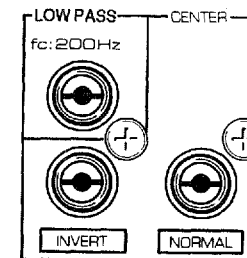

SETUP & ADJUSTMENT

operate. Also, the center input signal is sent to this jack when the Dolby Pro Logic switch is set to BYPASS.

④ Rear Output Jacks

These provide the Dolby Surround system's decoded surround sound signals. Connect these outputs to the left and right channel input jacks of the amp that will drive your rear speakers. Also, the left and right channel rear input signals are sent to this jack when Dolby Pro Logic switch is set to BYPASS.

⑤ Front Output Jacks

Connect these jacks to the amplifier that drives your main (front) speakers. If using an integrated amp or receiver, connect to the TAPE PB Jacks or, if your amp has them, the MAIN IN jacks.

⑥ Center/Rear Input Jacks

These jacks are useful for connecting to the center and rear channel outputs of an A/V amplifier. The signals are sent directly to the Center/Rear Output jacks when the Dolby Pro Logic switch is set to BYPASS, and are ignored otherwise.

⑦ Front Input Jacks

These accept input from a preamplifier, the "PRE OUT" or "TAPE REC" outputs from an integrated amplifier or receiver, or direct input from a line-level source such as a VCR player.

⑧ Tape Recording and Playback Jacks

This is the place to connect a tape deck if the tape jacks of your integrated amp or receiver will be occupied by connection to the DSR-70PRO.

⑨ Auxiliary AC Outlet (U.S.A., Canada, and General Model only)

You may plug other audio components into this socket as long as power consumption does not exceed 200 watts.

"Unswitched" means that power is available even when the DSR-70PRO is off.

⑩ Voltage Selector (General Model only)

Be sure this is set to the line voltage in your area before applying power.

Speakers & Speaker Placement

In a full 5-channel system you will use two sets of stereo speakers: the FRONT SPEAKERS (your normal stereo speakers), the REAR SPEAKERS, and the CENTER SPEAKER. You may also be using a SUBWOOFER.

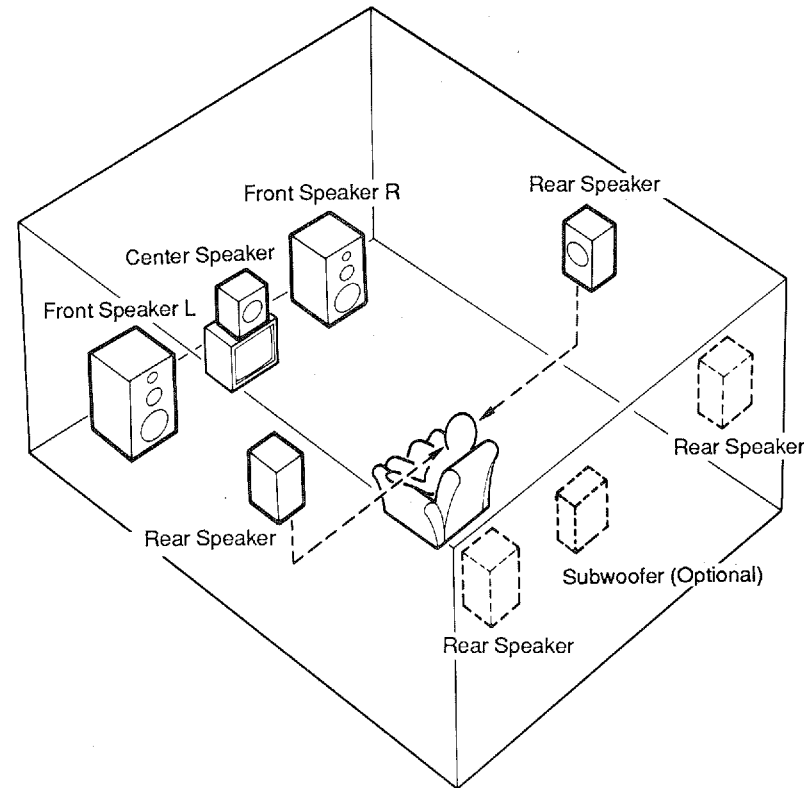

SETUP & ADJUSTMENT

You will probably use your present stereo speaker system for the FRONT SPEAKER pair. The rear and center speakers do not need to be of such high quality. But they should have high enough power handling to accept the maximum output of the amps that will drive them.

Place the FRONT SPEAKERS in the normal position.

Place the REAR SPEAKERS beside your listening position and facing inward. They should be nearly six feet up from the floor. If your power amp can drive two sets of speakers, all the better. Place the second pair behind you for even greater effectiveness.

Place the CENTER SPEAKER precisely between the two FRONT SPEAKERS. (To avoid interference, keep the speaker away from TV sets, or use a magnetically shielded speaker.)

If using a SUBWOOFER such as a Yamaha Electronic Super Woofer System, the position of the speaker is not so critical because low bass tones are not highly directional.

NOTE: Since most speakers are sold in pairs, you wish to use two speakers for the center channel (See page 13).

General Instructions for Connections

Use the supplied stereo cables or an equivalent high quality connection cable.

Make sure that you have the left (L) and right (R) channels correctly connected. That means that the jack marked "L" on the amp must be connected to the jack marked "L" on the DSR-70PRO. Likewise with the "R" jacks. This is easy if you remember to always use the red plugs for the "R" jacks and use the other plugs for the "L" jacks. By convention, "R" jacks are located below "L" jacks.

With speaker connections you must also be sure that the polarity is correct. For each amplifier and each channel, connect the plus (+) terminal of the amplifier to the plus terminal of the speaker, and connect the minus (-) terminal of the amplifier to the minus terminal of the speaker. To keep track of polarity, use speaker cable that has one of the two wires marked by a stripe or a different color.

SETUP & ADJUSTMENT

CONNECTING AN A/V AMPLIFIER

The DSR-70PRO has been especially designed to allow use with A/V amplifiers such as the Yamaha AVX-100. The DSR-70PRO automatically selects either the center and rear channel signals from the A/V amplifier (in BYPASS mode) or the center and rear channel signals generated internally by the DSR-70PRO (in Dolby Pro Logic ON mode).

1. Connect the DSR-70PRO's FRONT INPUT jacks to the A/V amp's Front Pre Out (FRONT OUTPUT) jacks.
2. Connect the DSR-70PRO's REAR INPUT jacks to the A/V amp's Rear Pre Out (REAR OUTPUT) jacks.
3. Connect the DSR-70PRO's CENTER INPUT jack to the Center Output (ENHANCED CENTER NORMAL OUTPUT) jack on the A/V amp. (Not necessary if no center speaker used.)
4. Connect the DSR-70PRO's FRONT OUTPUT jacks to the A/V amplifier's front power amplifier input (MAIN IN A) jacks.
5. Connect the DSR-70PRO's REAR OUTPUT jacks to the A/V amplifier's rear power amplifier input (MAIN IN B) jacks.
6. Connect the DSR-70PRO'S CENTER OUTPUT NORMAL jack to the input jack of the power amplifier to be used for the center speaker. (Not necessary if no center speaker used.)

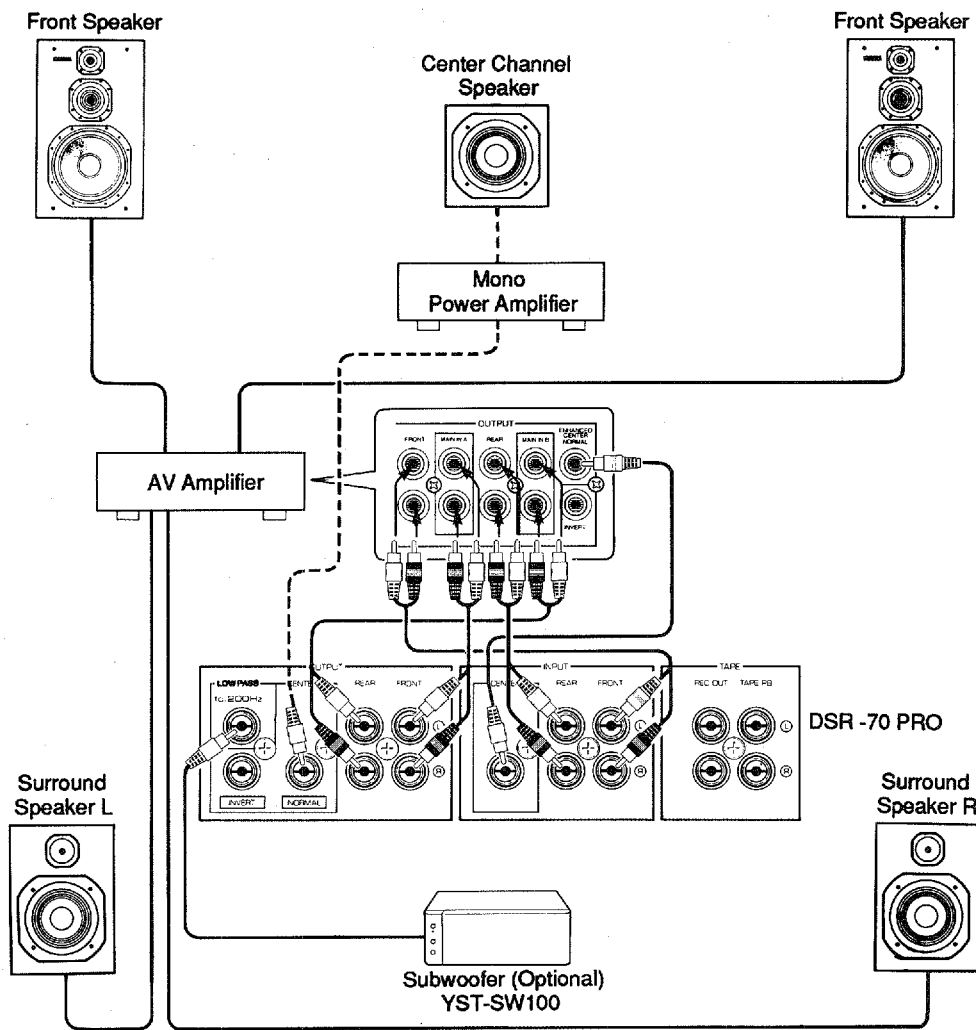

SETUP & ADJUSTMENT

CONNECTING THE MAIN INTEGRATED STEREO AMPLIFIER, STEREO RECEIVER OR COMPONENT PREAMPLIFIER AND POWER AMPLIFIER TO THE DSR-70PRO.

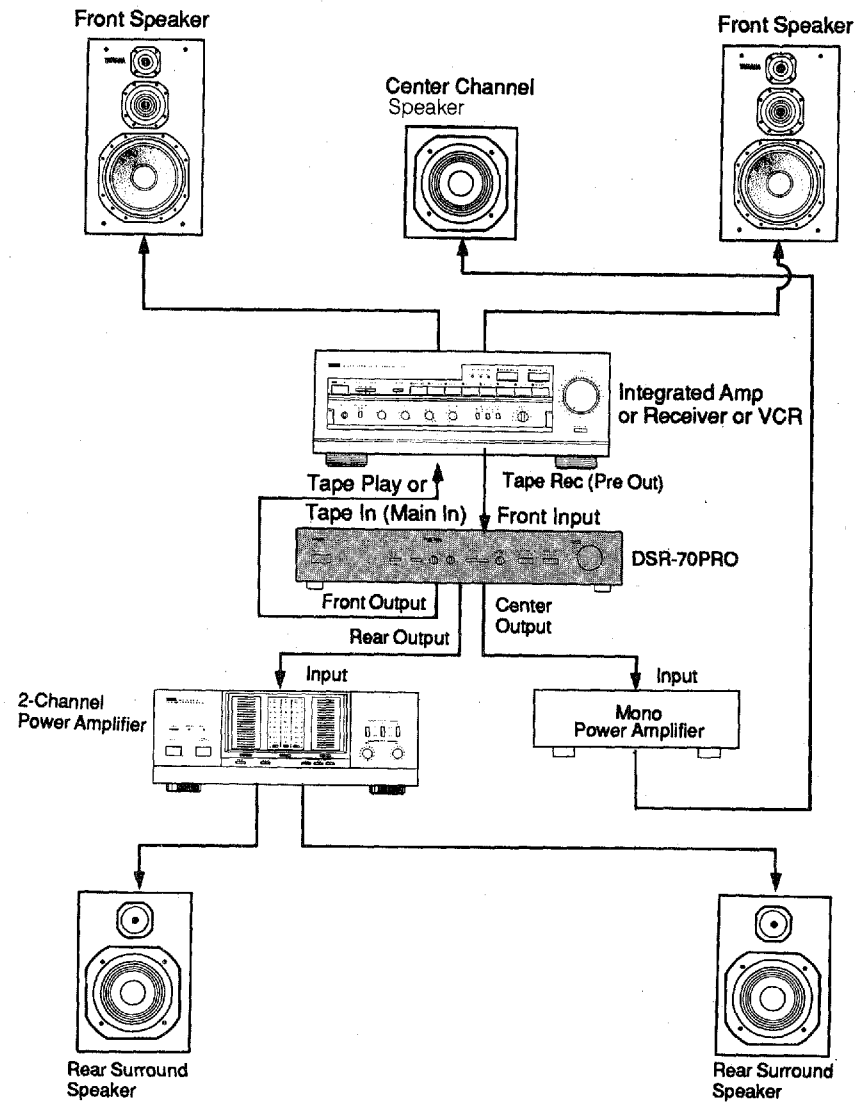

Using an Integrated Amplifier or Stereo Receiver Equipped with "PRE OUT" and "MAIN IN" Jacks.

Some integrated amplifiers and a few receivers are equipped with PRE OUT and MAIN IN jacks. These allow you to use the unit's preamp and power amp circuits independently of each other.

On some amps or receivers you will need to change a rear panel switch setting. On others you must remove the jumper cables that connect the PRE OUT jacks to the MAIN IN jacks.

Connect the PRE OUT jacks to the FRONT INPUT jacks on the DSR-70PRO rear panel.

Connect the DSR-70PRO's FRONT OUTPUT jacks to the MAIN IN jacks on the integrated amp or receiver.

Connect the FRONT SPEAKERS to the speaker terminals on the amp or receiver.

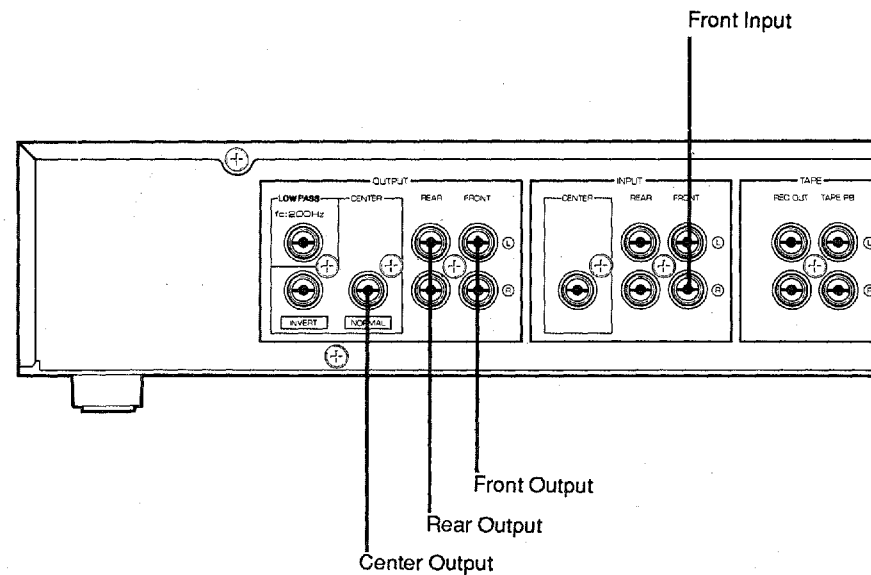

SETUP & ADJUSTMENT

Using an Integrated Amplifier or Stereo Receiver that Does Not Have "PRE OUT" and "MAIN IN" Jacks

Connect the amp or receiver TAPE REC (or TAPE OUT) jacks to the FRONT INPUT jacks on the DSR-70PRO rear panel.

Connect the DSR-70PRO's FRONT OUTPUT jacks to the TAPE PLAY (or TAPE IN) jacks on the integrated amp or receiver.

Connect the FRONT SPEAKERS to the speaker terminals on the amp or receiver.

NOTE: If connecting the DSR-70PRO displaces your tape deck, connect the deck to the DSR-70PRO rear panel TAPE PB and REC OUT jacks. The DSR-70PRO TAPE PB jacks connect to your deck's output or TAPE PLAY (Line Out) jacks. The REC OUT jacks connect to your deck's input or TAPE REC (Line In) jacks.

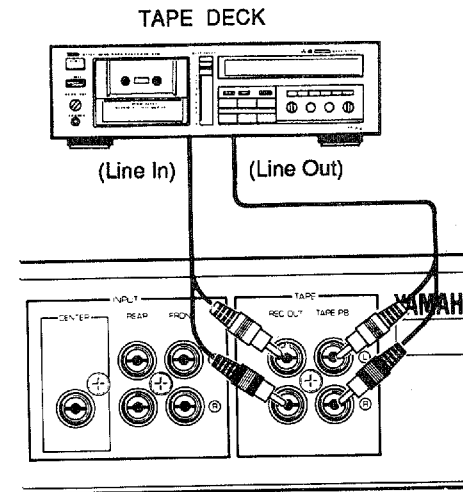

SETUP & ADJUSTMENT

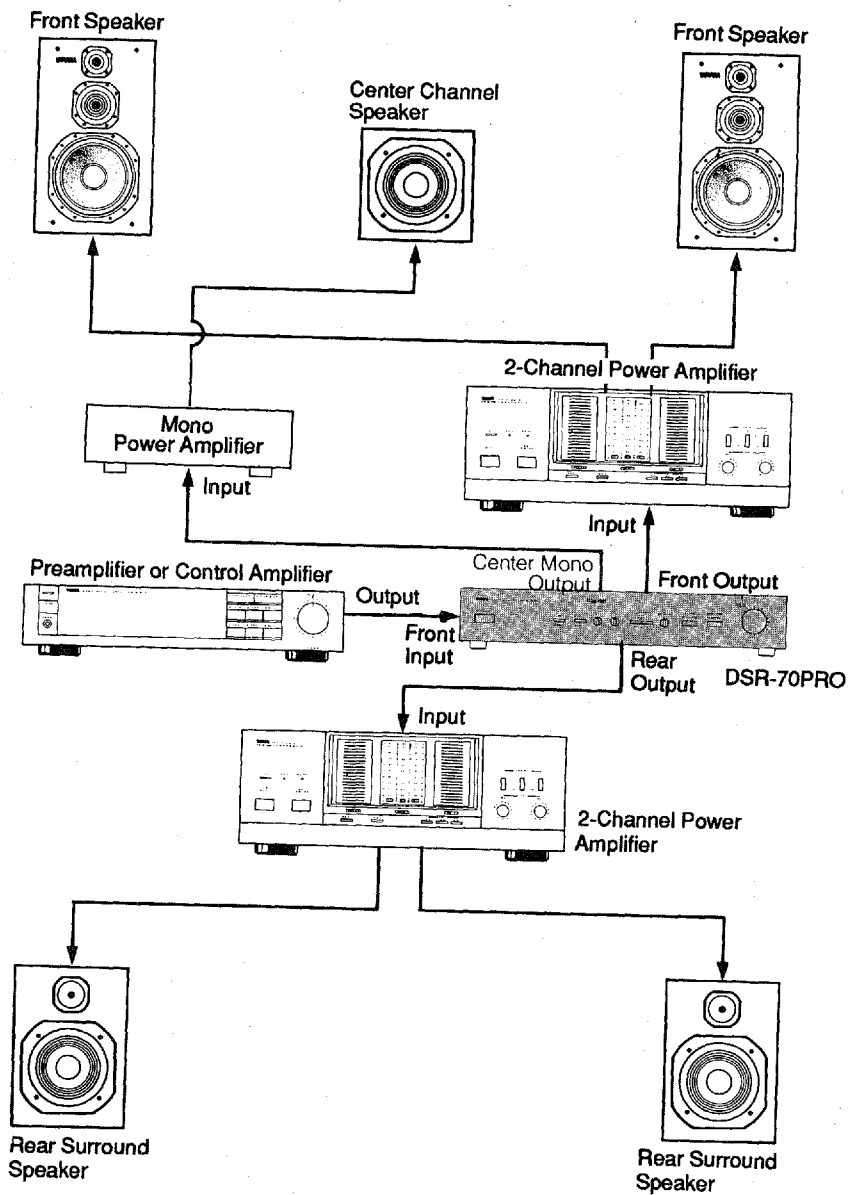

Using a Component Pre-amplifier (or Direct Connection from a Video Cassette Recorder) and Power Amplifier

Connect the output jacks of the pre-amplifier to the FRONT INPUT jacks on the DSR-70PRO rear panel. (Or connect the VCR's audio output jacks to the FRONT INPUT jacks on the DSR-70PRO rear panel.)

Connect the DSR-70PRO's FRONT OUTPUT jacks to the input jacks on your power amplifier.

Connect the FRONT SPEAKERS to the speaker terminals on the power amplifier.

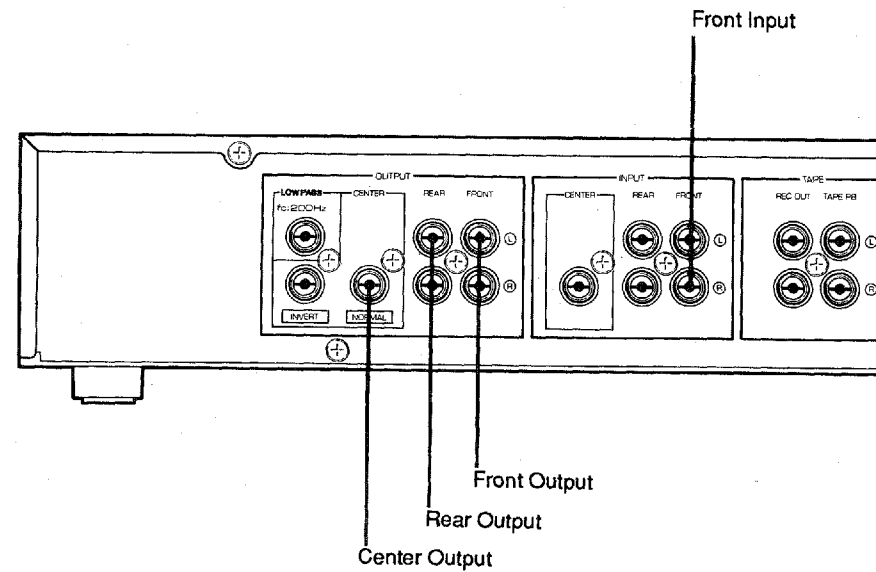

SETUP & ADJUSTMENT

CONNECTING THE REAR POWER AMPLIFIER AND SPEAKERS

Connect the DSR-70PRO's REAR OUTPUT jacks to the input jack of the power amplifier that will drive the REAR SPEAKERS.

Connect the speakers to the amplifier.

CAUTION: It is absolutely essential that all connections are matched according to channel, that is, left-to-left and right-to-right. In the case of the speaker terminals, you must also be careful to match the polarity of the terminals as well.

CONNECTING A CENTER AMPLIFIER AND SPEAKER AND/OR SUBWOOFER SYSTEM

True center channel capability is one of the most important features of the Dolby Pro Logic Surround system.

On the rear panel of the DSR-70PRO are three jacks in the section marked "CENTER". The NORMAL jack is for the DOLBY Pro Logic Surround center channel output. Connect this to the input jack on the center channel power amp. In turn, connect the CENTER SPEAKER to the speaker terminals on the amplifier. The INVERT jack can be used instead of the NORMAL jack when necessary to reverse the phase of the center speaker to bring it into phase with the front speakers.

Do the same for the DSR-70PRO subwoofer output jack (the upper jack marked "low pass fc:200Hz") if you will be using this option. A Yamaha Electronic Super Woofer System is highly suited to this purpose since it combines a mono power amp and subwoofer speaker in a single cabinet.

NOTE: The signals from these jacks are monophonic so separate mono amps are recommended to provide independent amplification. The use of a stereo power amp to handle both of these mono signals is another alternative.

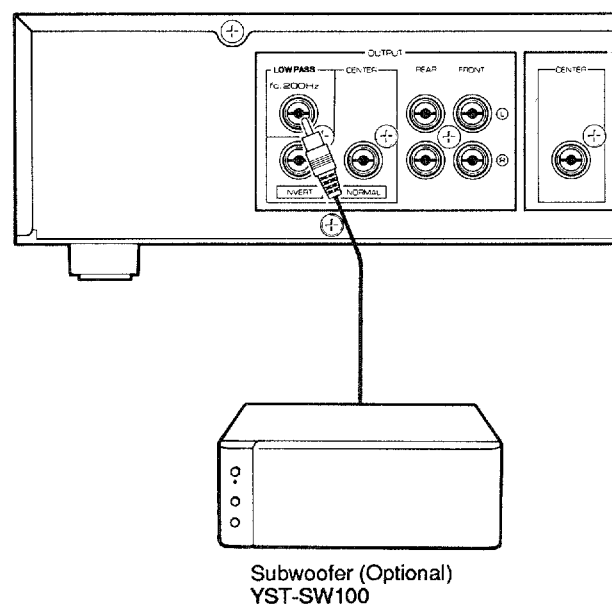

SETUP & ADJUSTMENT

USING A BTL STEREO AMPLIFIER TO DRIVE THE CENTER SPEAKER

When using a BTL-connectable power amp to drive the center speaker, BTL (balanced transformerless) connections may be used, for a more powerful, high quality sound.

1. Connect the DSR-70PRO OUTPUT, CENTER, NORMAL terminal to the left-channel input of the power amplifier.
2. Connect the OUTPUT CENTER INVERT terminal to the right-channel input of the power amplifier.
3. Connect the center speaker to the amplifier using BTL connections as explained in the amplifier's instruction manual.

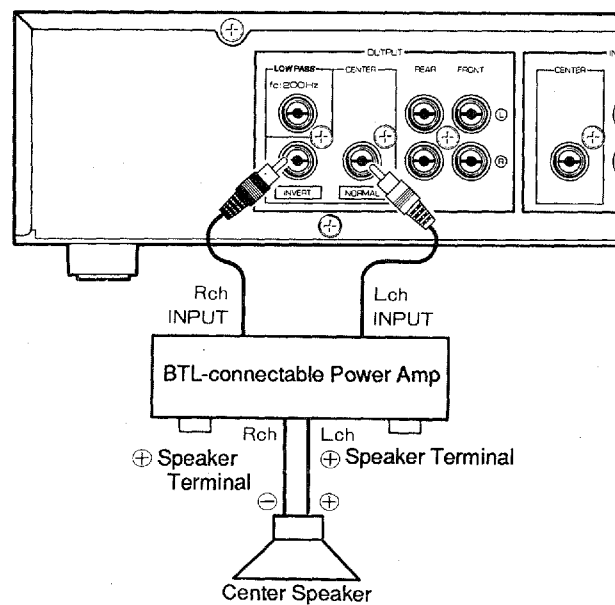

WHEN USING TWO CENTER SPEAKERS

A stereo power amplifier can be used to drive two center speakers in tandem.

1. Connect the DSR-70PRO OUTPUT CENTER NORMAL terminal to the left-channel input of the power amplifier.
2. Connect the OUTPUT CENTER INVERT terminal to the right-channel input of the power amplifier.
3. Connect the left-channel center speaker to the left speaker terminals with normal phase.
4. Connect the right-channel center speaker to the right speaker terminals with reversed phase (+ and - reversed).

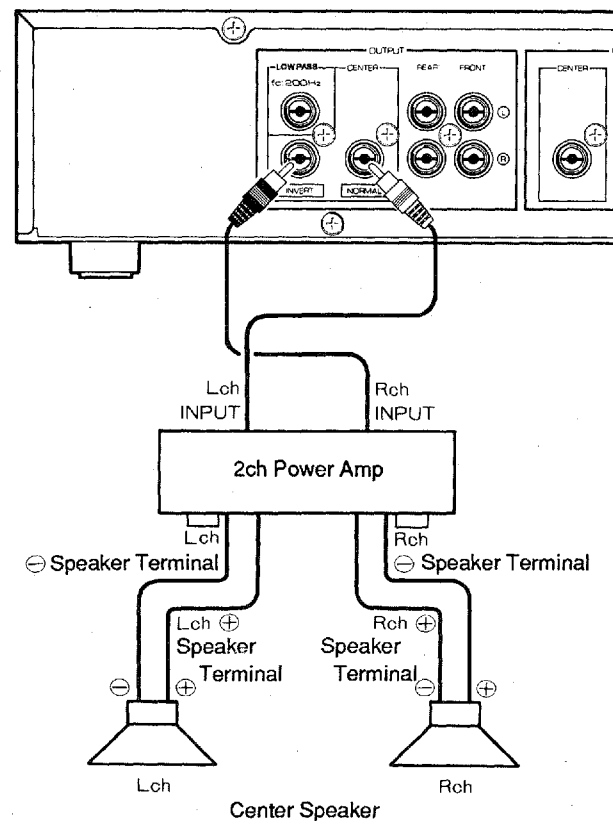

SETUP & ADJUSTMENT

1-4. CONTROLS & ADJUSTMENTS

FRONT PANEL

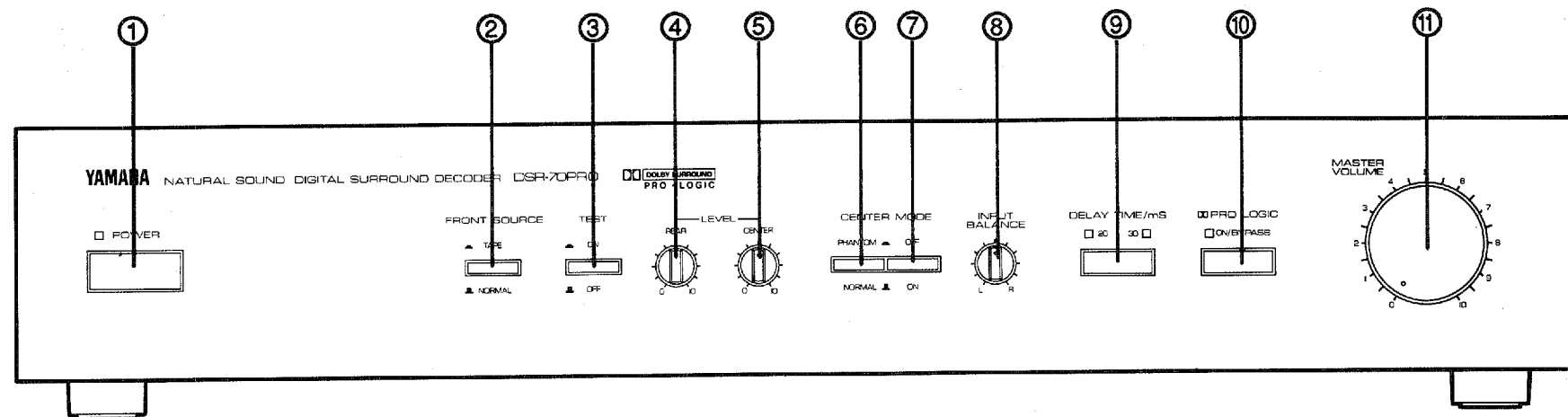

SETUP & ADJUSTMENTS

① Power Switch

Sound is muted for a few seconds after the power is switched on.

② Front Source Switch

Set this to the TAPE (depressed) position to listen to a tape deck connected to the DSR-70PRO rear panel TAPE jacks.

Set to the NORMAL position for normal operation.

③ Test Button

When this button is in the ON (depressed) position, the DSR-70PRO generates a pink noise signal that is sent in succession to the right, center, left, and surround channels. This function is useful for system calibration when adjusting the output level of the amps used to drive the various speakers.

④ Rear Level Control

Adjusts the rear Dolby Pro Logic Surround channel signal level.

⑤ Center Level Control

Adjusts Dolby Pro Logic center channel signal level. This has no effect in the "PHANTOM" mode.

This does not affect subwoofer output.

⑥ Center Mode Phantom/Normal Switch

Set to the ON position if you will be using a center speaker. Set to the PHANTOM position if you wish the center channel information to be reproduced through the conventional left and right channel front (main) speakers. (In either case, the center mode on/off switch must also be at the ON position.)

⑦ Center Mode On/Off Switch

This must be set to the ON position for normal operation.

The OFF position is used only when adjusting the input balance control.

⑧ Input Balance Control

This adjusts left/right input signal balance to optimize the operation of the Dolby Surround Logic matrix circuitry. Set the center mode switch to OFF while performing this calibration.

⑨ Delay Time Switch

Selects either 20ms or 30ms delay time for Dolby Surround operation.

⑩ Dolby Pro Logic Switch

When this switch is on (as confirmed by a lit LED above the key), the DSR-70PRO's Dolby Pro Logic Surround System actively decodes the input signal connected to the FRONT INPUT jacks.

This switch should be in the BYPASS position if your listening source is not Dolby Surround encoded. In this case, the FRONT, REAR, and CENTER inputs will be sent directly to the corresponding outputs.

⑪ Master Volume Control

This knob simultaneously controls signal level at all DSR-70PRO outputs: FRONT, CENTER (including subwoofer), and REAR. (This does not affect TAPE REC OUT level.)

SECTION 2 — PREPARATION

2-1. PREPARATION

1. Set volume to minimum on the preamplifier, integrated amplifier, or receiver.
2. Turn on the power to all components in the system.
3. Select your video cassette deck or video disc player (or other Dolby Surround encoded program source) as the source on your preamplifier, integrated amplifier, or receiver.
4. Begin playback of Dolby Surround encoded program material.
5. If you are using a power amplifier for the front channels, its volume control (if any) should be set to maximum. Volume controls on the amplifiers for the rear and center channel speakers should also be set to maximum.
6. Increase the setting of the volume control on your preamplifier, integrated amplifier or receiver to about the halfway point.

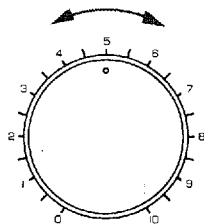

7. Set the DSR-70PRO master volume control knob to a comfortable listening level.

NOTE: The DSR-70PRO is designed to accept input signal levels of up to 3 volts. Distortion occurs if input signal level exceeds this value. On the other hand, noise increases if input level is insufficient.

2-2. INPUT BALANCE ADJUSTMENT

This adjustment should be performed to assure optimum performance of the Dolby Pro Logic Surround decoder.

1. Set the front panel CENTER MODE ON/OFF switch to the OFF position.
2. Begin playback of Dolby Surround encoded program material.

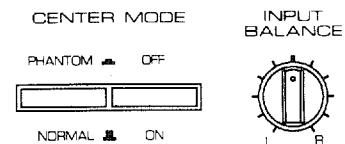

3. While listening to spoken dialog, adjust the input balance control so that the dialog volume (heard from the left and right front and rear speakers) is reduced to the minimum. (During normal operation, this dialog is reproduced over the center channel.)

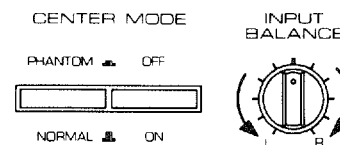

4. When you have completed this adjustment, be sure to return the front panel center mode on/off switch to the ON position.

PREPARATION

2-3. FRONT/CENTER/REAR SPEAKER BALANCE ADJUSTMENT

Using the built-in test tone generator, this procedure lets you adjust the volume balance between the front, center, and rear speakers. This adjustment is important for proper Dolby Pro Logic Surround operation.

1. Turn on the Dolby Pro Logic switch.

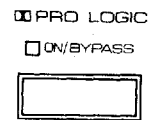

2. Turn on the TEST button.

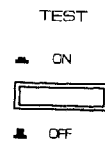

3. Turn up the DSR-70PRO's MASTER VOLUME control. You will hear a test tone (pink noise) from the right front speaker, then the center speaker, then the left front speaker, then the rear speakers, for about two seconds each.

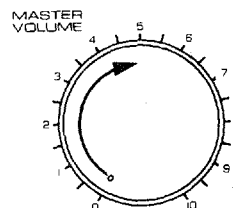

4. Adjust the REAR LEVEL and CENTER LEVEL controls so that the volume heard at the listening position is the same from each speaker.

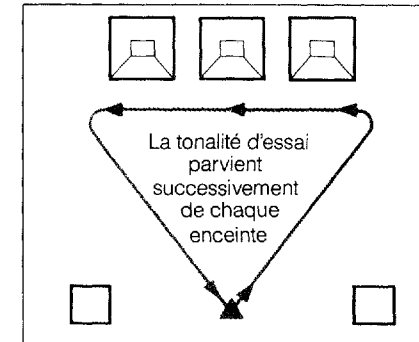
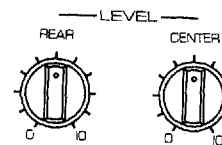

• If not using a center speaker, be sure to set the front panel center phantom/normal switch to the PHANTOM position. You will then hear the center channel test tone from the left and right front speakers.

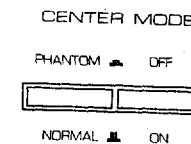

• If you can not achieve sufficient REAR speaker volume to match the FRONT speaker volume and you are using an integrated amp, try turning down the amplifier's volume until front/rear balance is achieved.

After completing this adjustment, turn off the front panel TEST button.

NOTE: Once you have completed these adjustments, use only the DSR-70PRO MASTER VOLUME control knob to adjust listening volume.

Do not change any other volume settings in the system.

SECTION 3 — GENERAL OPERATION

3-1. PLAYBACK WITH DOLBY SURROUND

1. Turn on the power on all components in the system.
2. Turn on the Dolby Pro Logic switch.
3. Select your input source on the preamplifier, integrated amplifier, or receiver.
 - If the source is a tape deck connected to the DSR-70PRO rear panel tape jacks, then set the FRONT SOURCE switch to the TAPE position.
4. Adjust the master volume control knob on the DSR-70PRO front panel.
5. If necessary, use the Delay Time switch to change the delay time setting.
6. If necessary, adjust the front panel center and rear level controls to match your listening source.

NOTE: The Dolby Pro Logic Surround system is designed to be used with program material (mainly videotaped movie soundtracks) that is encoded with the Dolby Surround system. The results with material not encoded with Dolby Surround may be unnatural.

NOTE: Some amplifiers and receivers have built-in surround sound or ambience processing circuitry. If this is the case in your system, then be sure that the surround or ambience circuitry is off on the source amp or receiver while you are using the DSR-70PRO's Dolby Pro Logic Surround decoding function.

3-2. ORDINARY STEREO REPRODUCTION

Set the Dolby Pro Logic switch to the BYPASS position. Then operate your system components as usual. Surround or ambience circuits in your other equipment may be used in the BYPASS position.

- Be sure to turn on the power on the DSR-70PRO.
- If the source is a tape deck connected to the DSR-70PRO rear panel tape jacks, then set the front source switch to the TAPE position.

3-3. SOURCE SELECTION WITH TAPE LOOP CONNECTION

If your integrated amp or receiver tape jacks are used for connection to the DSR-70PRO, then the amp or receiver looks at the DSR-70PRO as if it were a tape deck. Therefore, you must set the amp or receiver as if you were going to make a tape recording of your desired listening source.

If the amp or receiver has a REC SELECTOR, set it to your desired listening source.

If it does not have a REC SELECTOR, simply select your listening source using the usual controls.

Turn on the TAPE MONITOR switch on the amp or receiver.

NOTE: If the DSR-70PRO is connected to the tape jacks on an integrated amp or receiver, then all of the tape related control (tape monitor switch, tape deck selector, rec out selector, and tape dubbing selector controls) may affect operation. It is therefore necessary to pay special attention to the settings of these controls in order to assure the correct routes for the signals.

3-4. RECORDING ON A DECK CONNECTED TO THE DSR-70PRO

You can make tape recordings at any time, regardless of switch and control knob settings on the DSR-70PRO. The DSR-70PRO's rear panel TAPE REC OUT jacks provide the same signal as is input to its FRONT INPUT jacks.

However, the recorded signal does not include the effect of the Dolby Pro Logic Surround decoder.

SECTION 4 — APPENDIX

4-1. TROUBLESHOOTING

Most problems can be corrected by making a change in the connections or control settings.

If there is a problem with your system, please check this chart to find the probable cause.

If trouble persists despite corrective measures, contact your Yamaha service station.

SYMPTOM	CHECK POINTS	REMEDY
Power does not turn on even when the power switch is pressed.	AC cord is not properly plugged in.	Plug in AC cord of DSR-70PRO and other units.
No sound.	Audio cables are not properly connected. Wrong source selected on amp or receiver. DSR-70 front source switch is set to tape.	Connect all cables, plugging them firmly into correct jacks. Select the desired input source and/or set the rec selector and tape monitor switch to the correct setting on the amp or receiver. Set the front source switch to NORMAL.
No sound from rear speakers.	Front panel rear level control is turned down. Front panel Dolby Pro Logic switch is not turned on when listening to a Dolby Pro Logic Surround encoded source. Source does not have rear channel information.	Turn up rear level control. Turn on Dolby Pro Logic switch when listening to Dolby Pro Logic Surround encoded sources. Use a Dolby Pro Logic Surround encoded source.
Sound is muffled.	Dolby Pro Logic switch is on but source is mono or not encoded with Dolby Surround.	Turn off Dolby Pro Logic switch when listening to sources that are not Dolby Surround encoded.
Sound is "thin."	Center mode phantom/normal switch is set to "normal" when no center speaker is used.	Set center mode switch to "phantom" position if no center speaker is used.
No sound from center speaker	Center channel on/off switch is turned off. Center mode phantom/normal switch is set to "phantom" when using a center speaker. Front panel center level control is turned down.	Set center channel switch to "ON" position. Set center mode switch to "ON" position. Turn up center level knob.
Interference in TV picture.	Magnetic field from nearby speaker is interfering with electron beam scanning.	Use special shield speaker system for center speaker or move TV set away from speaker position.
Tape recordings from DSR-70PRO do not include Dolby Pro Logic Surround effect.	This is normal.	You can only record the same signal as is input to the DSR-70PRO.
Unnatural Dolby Pro Logic Surround effect.	Source amp or receiver has built-in surround circuitry that is turned on.	Turn off surround effect on source amp or receiver.

APPENDIX

4-2. SPECIFICATIONS

Audio Specifications (Dolby Surround BYPASS)

THD:	0.02% (1kHz, 1V rms)
Residual noise:	20 microvolts (IHF A)
Frequency response:	10Hz—50kHz (+0, -3dB)

Surround Decoder :

Digital delay sampling frequency:	49.7kHz, 14-bit floating point.
Digital delay time:	20, 30ms
Input capacity:	2.0V rms
S/N ratio:	76dB

Input/Output

Input impedance:	10 kohms
Output impedance:	front/rear/center 1 kohm low pass 5 kohms
Input sensitivity:	150mV

Power Requirement

U.S.A. model:	AC 120V, 60Hz
---------------	---------------

Dimensions(W/H/D): 435 x 81 x 363mm

Weight: 3.9kg

Power consumption: 11W

AC outlet: 200W maximum, unswitched
(not provided in Europe, Britain
and Australia)

YAMAHA

YAMAHA ELECTRONICS CORPORATION, USA 6722 ORANGETHORPE AVE., BUENA PARK, CALIF. 90620, U.S.A.
YAMAHA CANADA MUSIC LTD. 135 MILNER AVE., SCARBOROUGH, ONTARIO M1S 3R1, CANADA
YAMAHA ELECTRONIK EUROPA G.m.b.H. 2084 RELINGEN, BEI HAMBURG, SIEMENSSTR. 22/34, F.R. OF GERMANY
YAMAHA ELECTRONIQUE FRANCE S.A. 17 RUE DES CAMPANULES, LOGNES 77321 MARNE LA VALLEE CEDEX 2, FRANCE
YAMAHA ELECTRONICS (UK) LTD. YAMAHA HOUSE, 200 RICKMANSWORTH ROAD WATFORD, HERTS WD1 7JS, ENGLAND
YAMAHA SCANDINAVIA A.B. J A WETTERGRENS GATA 1, BOX 30053, 400 43 VÄSTRA FRÖLUNDA, SWEDEN
YAMAHA MUSIC AUSTRALIA PTY, LTD. 17-33 MARKET ST., SOUTH MELBOURNE, 3205 VIC., AUSTRALIA

YAMAHA CORPORATION
10-1 NAKAZAWA-CHO, HAMAMATSU, JAPAN
VI21530-0 Printed in Japan BWgW. g ㉿